

2014 OK Red Conference Tennis Tournament

Team Rosters

	East Kentwood	Grand Haven	Grandville
	Coach: Duy Tran	Coach: Jeremy Case	Coach: Amy Kool
1S	Kim-Anh Tran	Erin Staal	Isabella Buck
2S	Macey Hodge	Meghan Hendrickson	Quincey Glupker
3S	Abigail Plummer	Julia Bachmann	Sami Sagorski
4S	Megan Hippe	Gretchen Kelly	Brynn Meulenber
1D	Cindy Nguyen	Adi Smith	Bethany VanGessel
1D	Ellie Englis	Maggie Ginnocchio	Shelby Bargenqast
2D	Ajla Grudic	Melissa Eveland	Jessica Abraham
2D	Marilyn Padua	Ellery Murphy	Rachel Lau
3D	Linh-Nhu Hoang	Nicolette Birkett	Lexi Lang
3D	Melissa Dam	Josie Hendrickson	Kristen Apsey
4D	Tien Tran	Amelia Donohoe	Renee Steenwyk
4D	Morgan Clarke	Hailey Watkins	Hannah Mekkes
	Hudsonville	Rockford	West Ottawa
	Coach: Paul Bentley	Coach: Tom Huising	Coach: Peter Schwallier
1S	Amanda Moore	Allyson Healy	Kelly Burns
2S	Taylor LaBarge	Adeline Nelson	Casey Foster
3S	Ivana Nujic	Alyssa Bowman	Susan Fender
4S	Erin LaBarge	Lauren Mirecki	Bethany Paarlberg
1D	Morgan Brodien	Courtney Fedeson	Kelly Hayes
1D	Maddie Brouwer	Jillian Day	Leah Denbleyker
2D	Elizabeth Jones	Paula Downs	Makenna VanDyne
2D	McKenna Lee	Maddie VanEck	Emily Hofmeyer
3D	Olivia Hoppen	Grace Kropiewnicki	Hannah Karp
3D	Dawson Bishop	Lydia Elford	Lauren Kuiper
4D	Katlya Tanis	Sam Harrell	Jacklyn Vandepoel
4D	Harley Swainston	Kara Przybylski	Lauren Valentine

FINAL RESULTS

2014

OK Red Conference Tennis Tournament

	1S	2S	3S	4S	1D	2D	3D	4D	Total	Place
East Kentwood	3	2	1	2	1	1	1	1	12	6 TH
Grand Haven	4	1	4	3	5	3	4	3	27	3 RD
Grandville	2	6	3	1	4	2	2	2	22	5 TH
Hudsonville	6	4	6	6	6	6	6	5	45	1 ST
Rockford	5	3	5	5	3	5	5	4	35	2 ND
West Ottawa	1	5	2	4	2	4	3	6	27	3 RD

	OK Red Dual Points	OK Red Tournament Points	Total Points	OK Red Final Standings
Hud	6	6	12	1st
R	5	5	10	2nd
GH	4	3.5	7.5	3rd
WO	3	3.5	6.5	4th
GV	2	2	4	5th
EK	1	1	2	6th

2014 OK Red Conference Tennis Tournament

1 Singles

flight

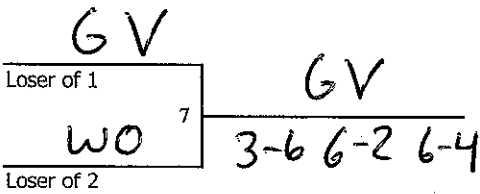
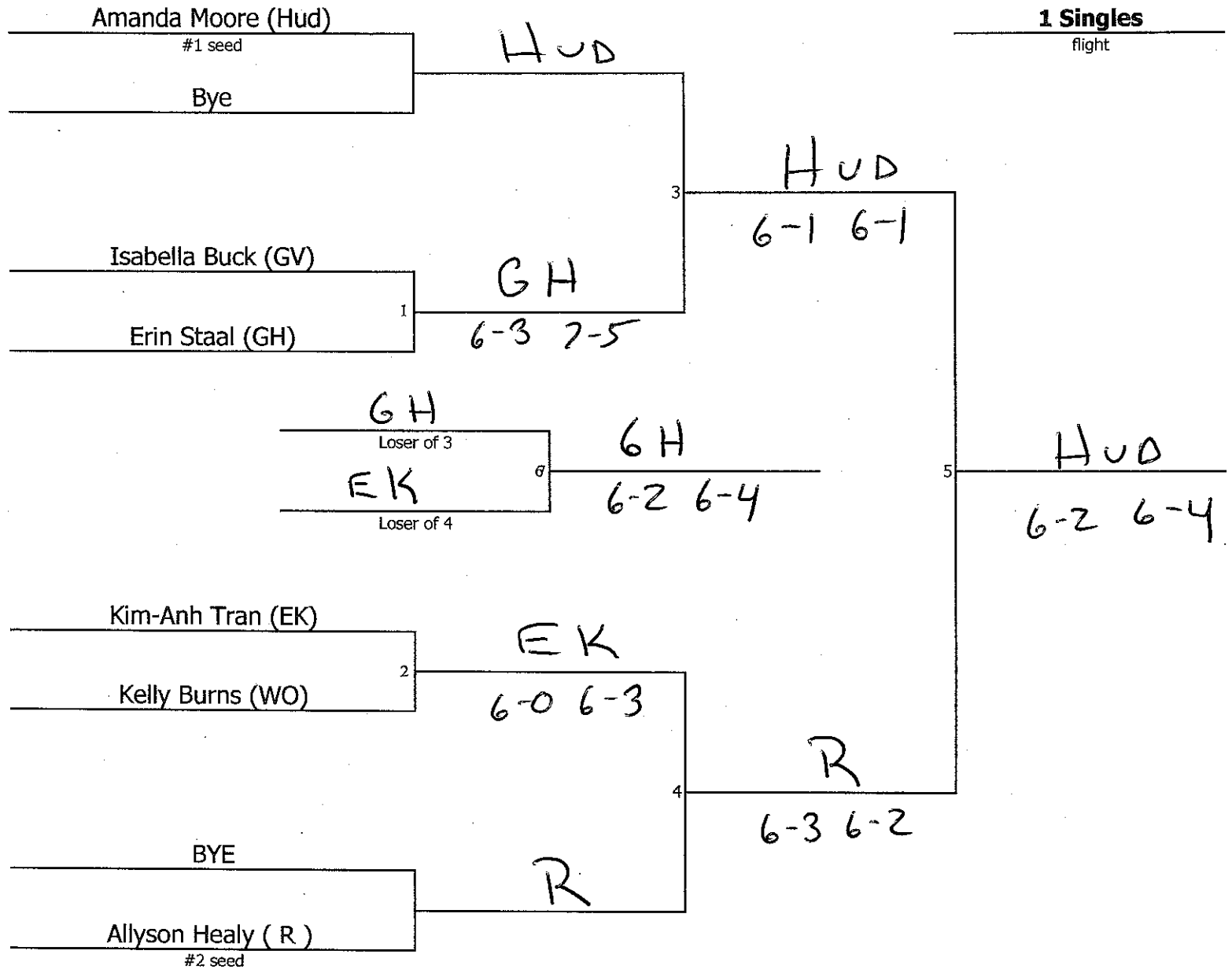

Position Finished = Points Earned

- Winner of #5 = 6 points
- Loser of #5 = 5 points
- Winner of #6 = 4 points
- Loser of #6 = 3 points
- Winner of #7 = 2 points
- Loser of #7 = 1 point

2014 OK Red Conference Tennis Tournament

2 Singles
flight

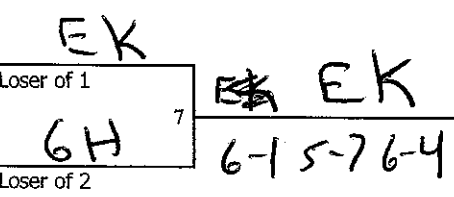
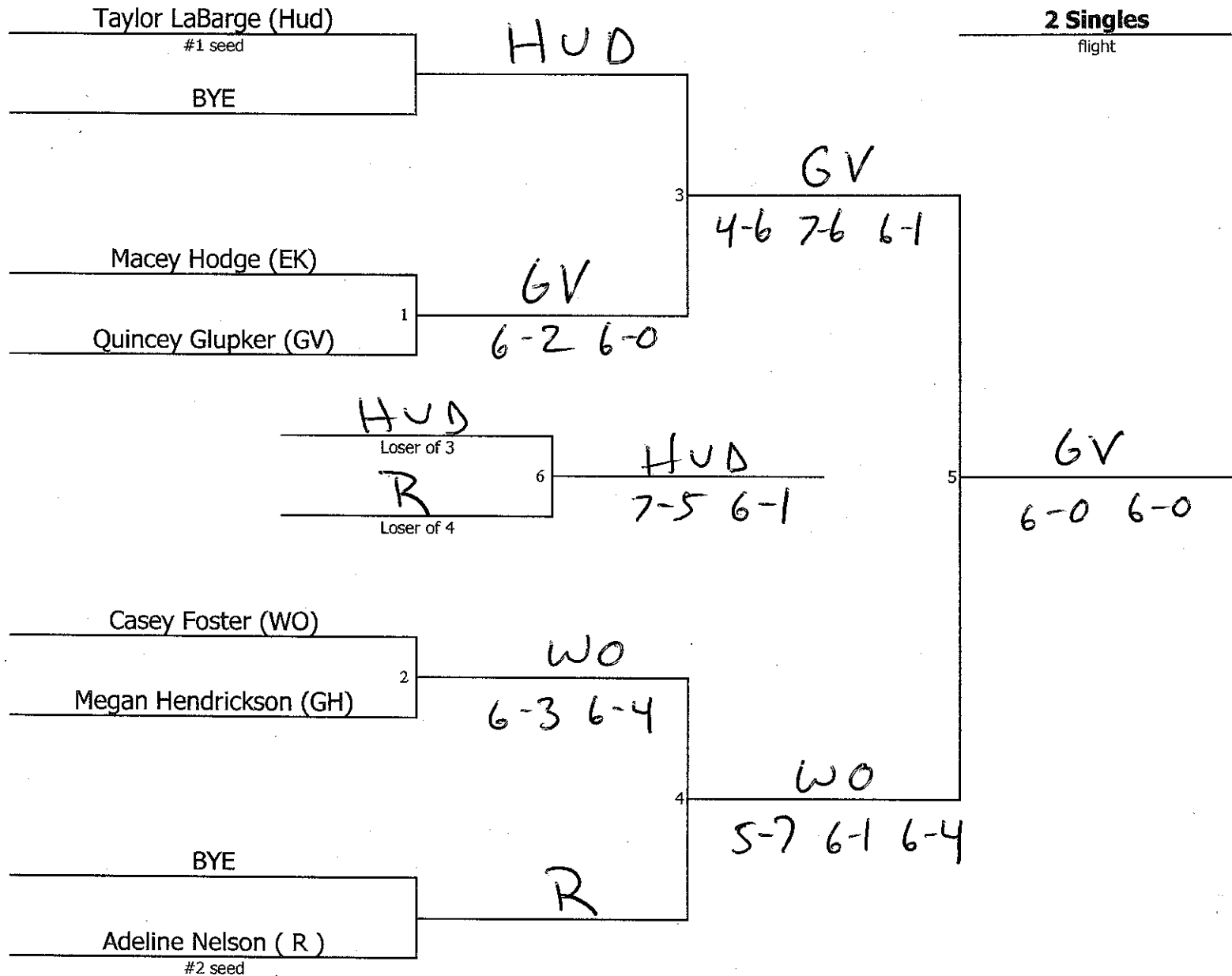

Position Finished = Points Earned

- Winner of #5 = 6 points
- Loser of #5 = 5 points
- Winner of #6 = 4 points
- Loser of #6 = 3 points
- Winner of #7 = 2 points
- Loser of #7 = 1 point

2014 OK Red Conference Tennis Tournament

3 Singles
flight

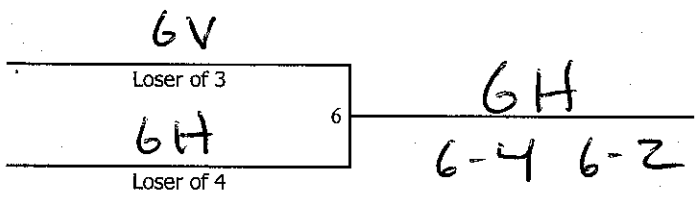
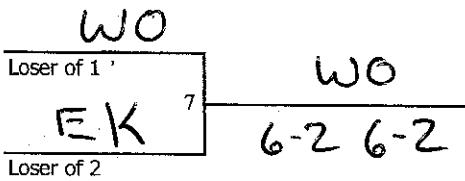
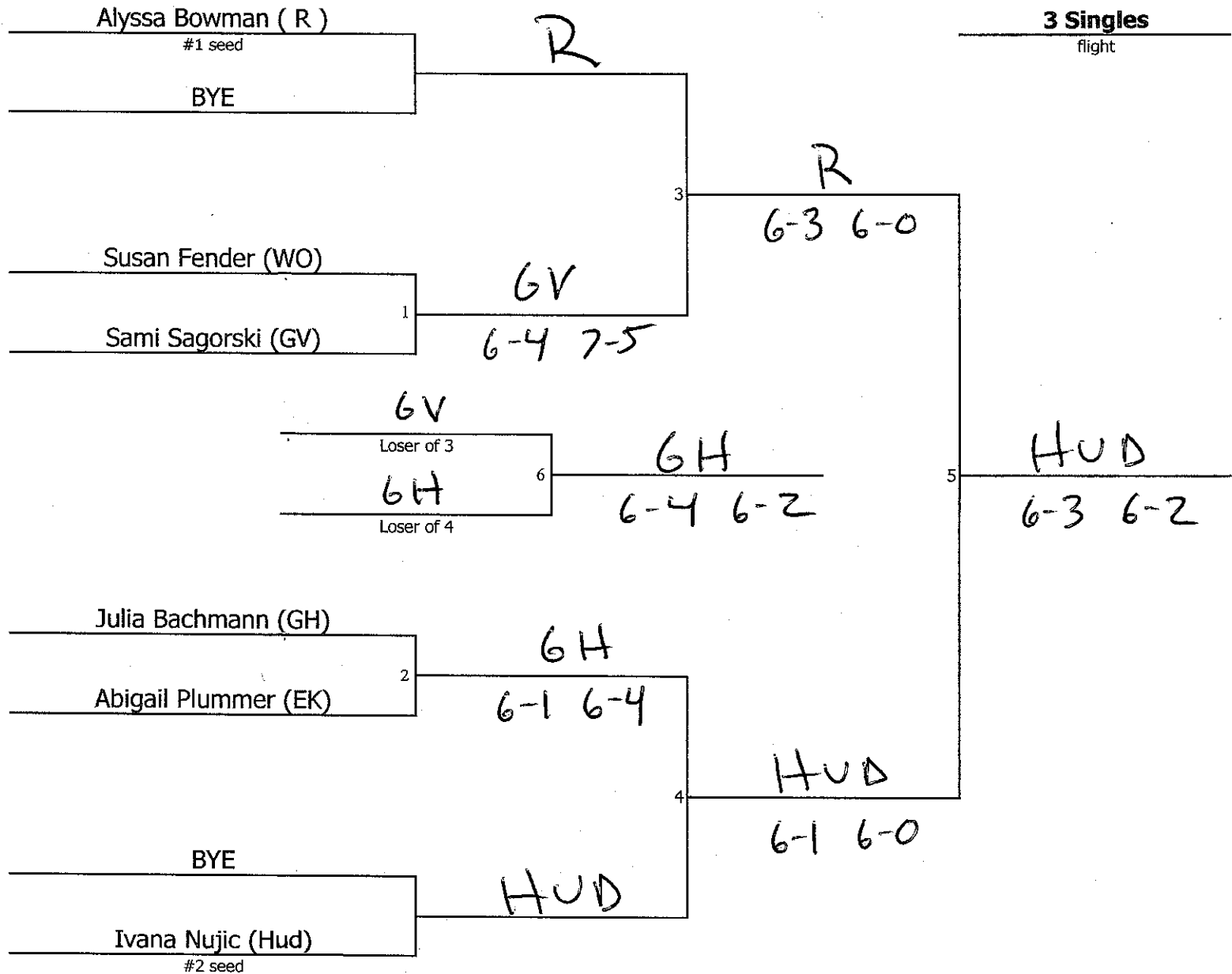

Position Finished = Points Earned

- Winner of #5 = 6 points
- Loser of #5 = 5 points
- Winner of #6 = 4 points
- Loser of #6 = 3 points
- Winner of #7 = 2 points
- Loser of #7 = 1 point

2014 OK Red Conference Tennis Tournament

4 Singles flight

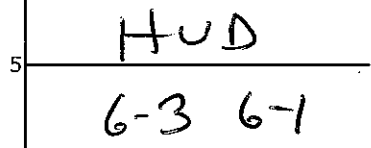
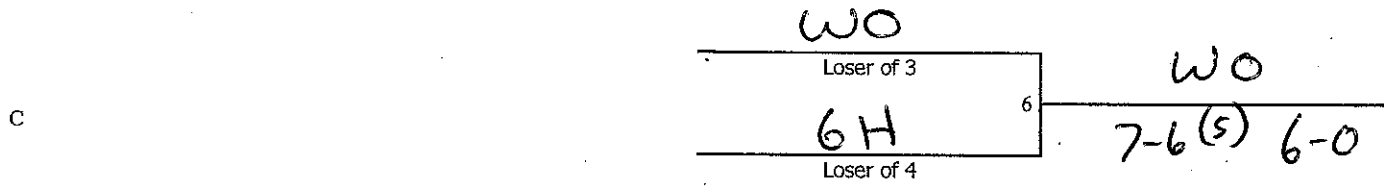
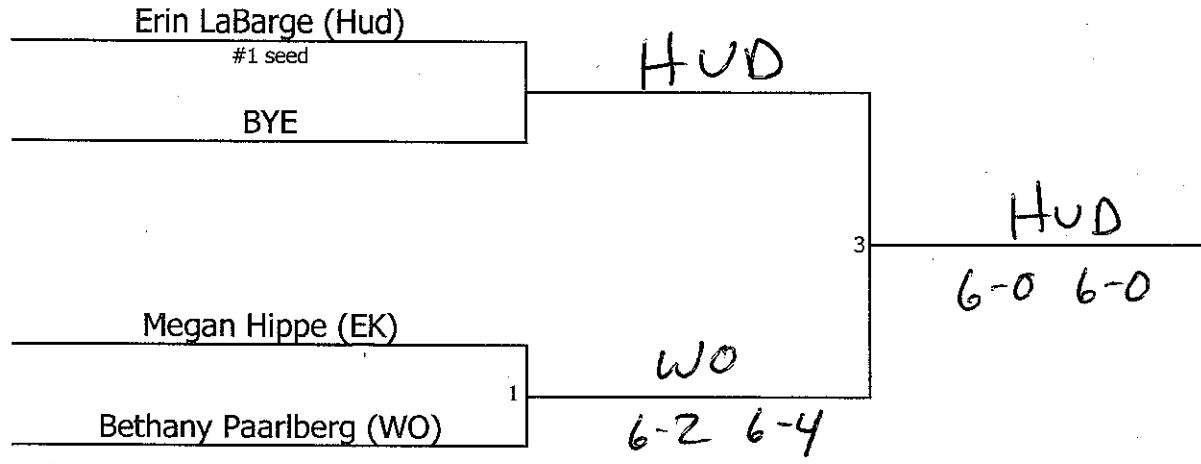
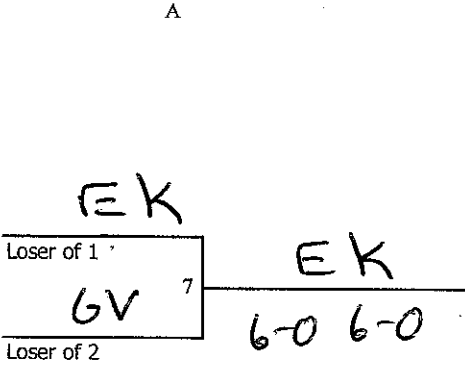

Position Finished = Points Earned

- Winner of #5 = 6 points
- Loser of #5 = 5 points
- Winner of #6 = 4 points
- Loser of #6 = 3 points
- Winner of #7 = 2 points
- Loser of #7 = 1 point

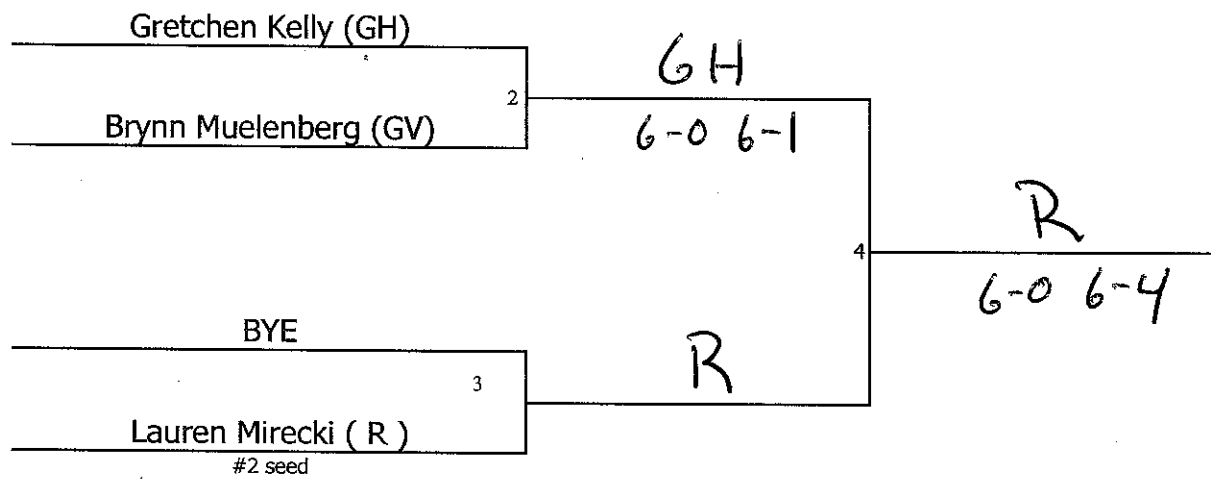

2014 OK Red Conference Tennis Tournament

1 Doubles

flight

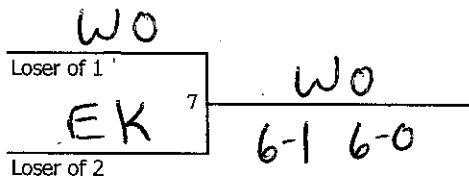
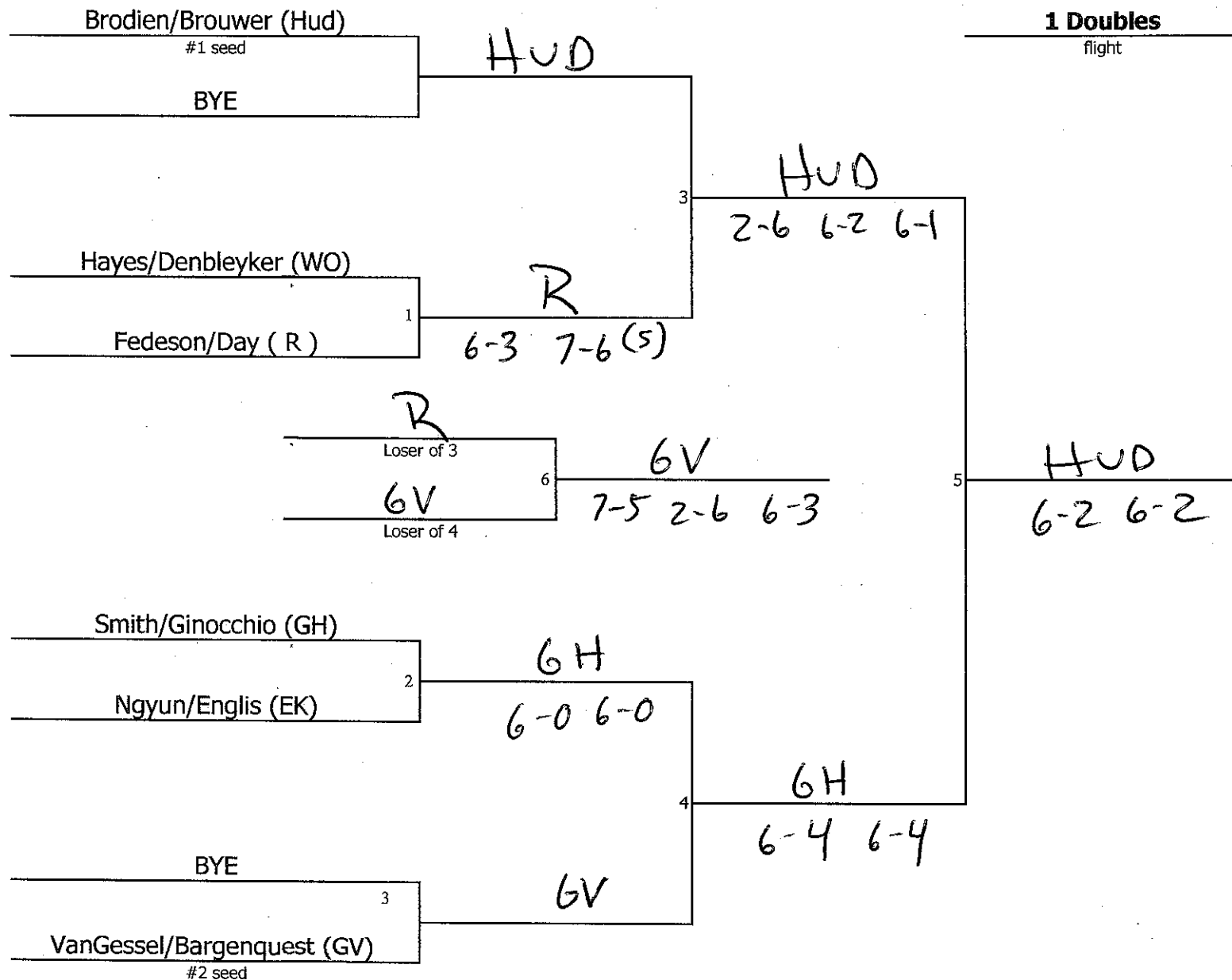

Position Finished = Points Earned

- Winner of #5 = 6 points
- Loser of #5 = 5 points
- Winner of #6 = 4 points
- Loser of #6 = 3 points
- Winner of #7 = 2 points
- Loser of #7 = 1 point

2014 OK Red Conference Tennis Tournament

2 Doubles
flight

A

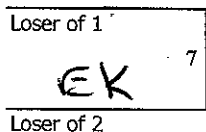
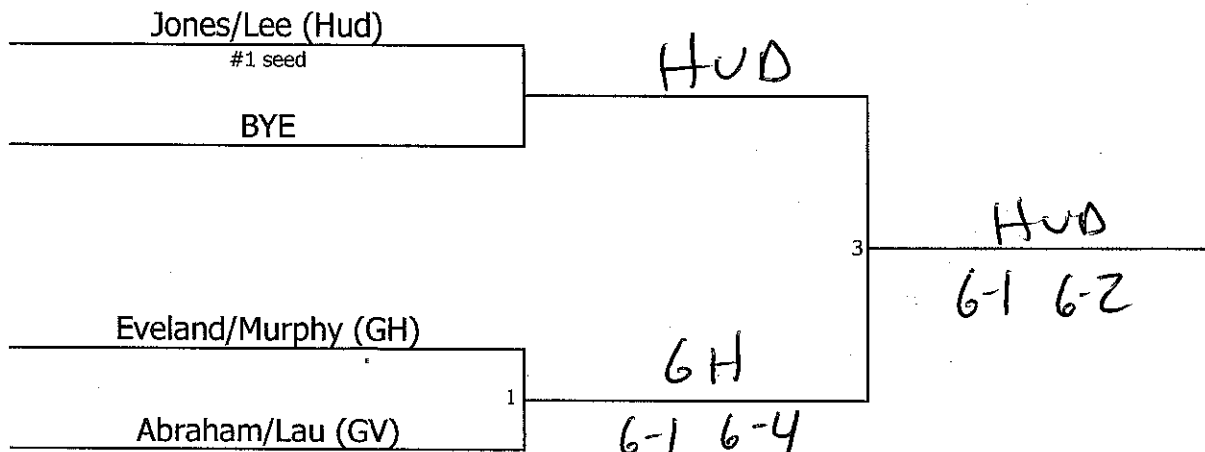

6-1 6-0

C

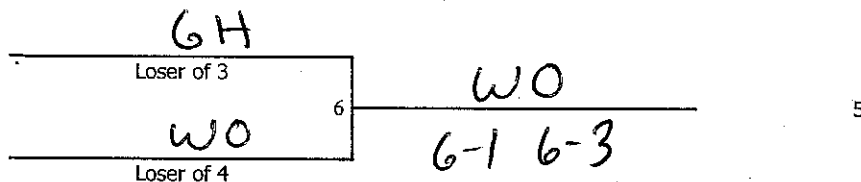

Hud
6-4 6-4

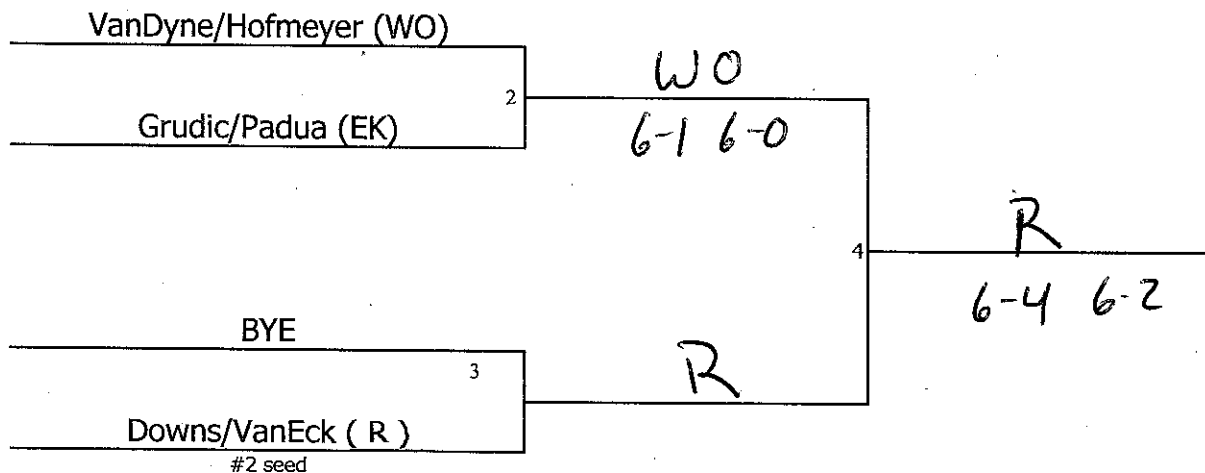

Position Finished = Points Earned

- Winner of #5 = 6 points
- Loser of #5 = 5 points
- Winner of #6 = 4 points
- Loser of #6 = 3 points
- Winner of #7 = 2 points
- Loser of #7 = 1 points

2014 OK Red Conference Tennis Tournament

3 Doubles
flight

A

Hoppen/Bishop (Hud)
#1 seed
BYE

HUD

Lang/Apsey (GV)
Birkett/Hendrickson (GH)
1

GH
6-1 6-1

3
HUD
6-4 6-4

C

6H
Loser of 3
WO
Loser of 4
6

6H
6-2 7-6 (1)

5
HUD
6-3 4-6 6-2

Karp/Kuiper (WO)
Hoang/Dam (EK)
2

WO
6-2 6-0

BYE
Elford/Kropiewnicki (R)
#2 seed
3

R

4
R
6-4 3-6 6-4

Position Finished = Points Earned

- Winner of #5 = 6 points
- Loser of #5 = 5 points
- Winner of #6 = 4 points
- Loser of #6 = 3 points
- Winner of #7 = 2 points
- Loser of #7 = 1 points

GV
Loser of 1
EK
Loser of 2
7
GV
6-1 6-3

2014 OK Red Conference Tennis Tournament

4 Doubles
flight

